

TCM60-05-SERIES

Standard Linear Stage, 0.5" Travel Series. An external mounting structure allows easy-connection with the tapped holes. One-piece design offers the highest verticality in XY direction and can also be assembled into a 3-axis stage.

ITEM	PLATFORM SIZE	ACTUATORS	AXIS	TRAVEL	STRAIGHTNESS	PARALLELISM	RESOLUTION	LOAD
TCM60XY-05-L	40x60mm	Micrometer	XY	+/-6.5mm	+/-15um	+/-15um	10um	5kg
TCM60XY-05-R	40x60mm	Micrometer	XY	+/-6.5mm	+/-15um	+/-15um	10um	5kg
TCM60XY-05A-L	40x60mm	100 TPI	XY	+/-6.5mm	+/-15um	+/-15um	NA	5kg
TCM60XY-05A-R	40x60mm	100 TPI	XY	+/-6.5mm	+/-15um	+/-15um	NA	5kg
TCM60XYZ-05-L	40x60mm	Micrometer	XYZ	+/-6.5mm	+/-15um	+/-15um	10um	5kg
TCM60XYZ-05-R	40x60mm	Micrometer	XYZ	+/-6.5mm	+/-15um	+/-15um	10um	5kg
TCM60XYZ-05A-L	40x60mm	100 TPI	XYZ	+/-6.5mm	+/-15um	+/-15um	NA	5kg
TCM60XYZ-05A-R	40x60mm	100 TPI	XYZ	+/-6.5mm	+/-15um	+/-15um	NA	5kg
TCM60Z-05	40x60mm	Micrometer	Z	+/-6.5mm	+/-15um	+/-15um	10um	5kg
TCM60Z-05A	40x60mm	100 TPI	Z	+/-6.5mm	+/-15um	+/-15um	NA	10kg

TCM60XY-05-L

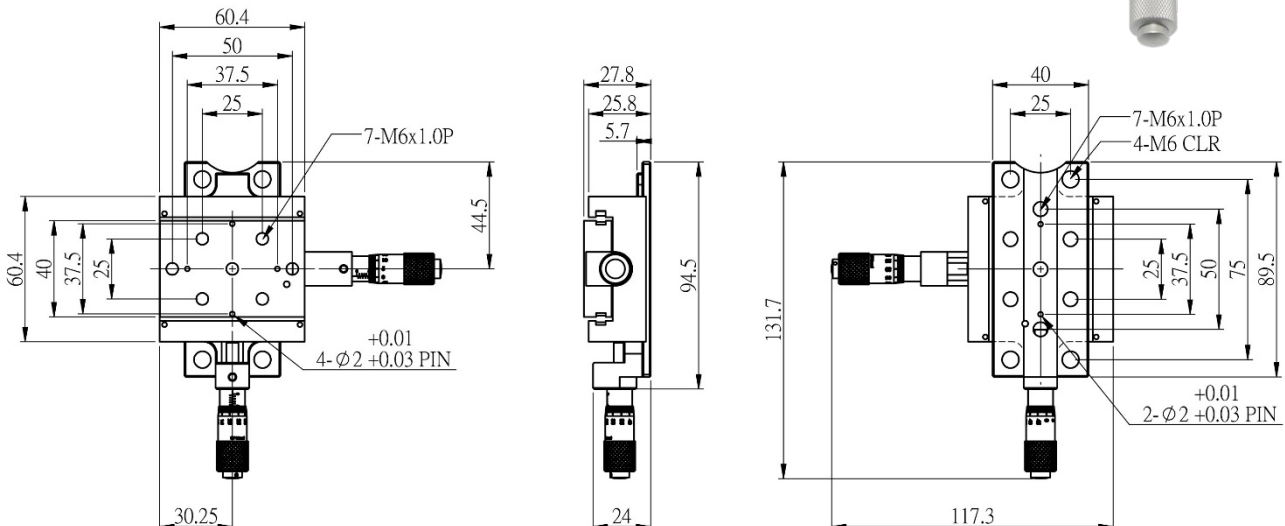

TCM60XY-05-R

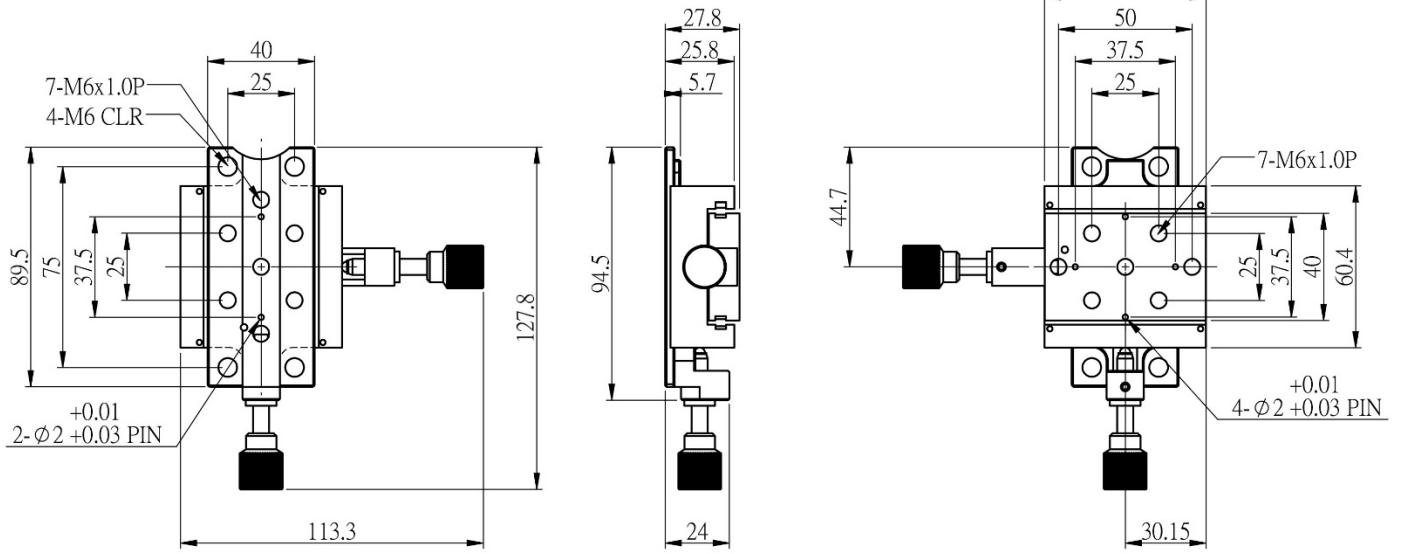

TCM60XY-05A-L

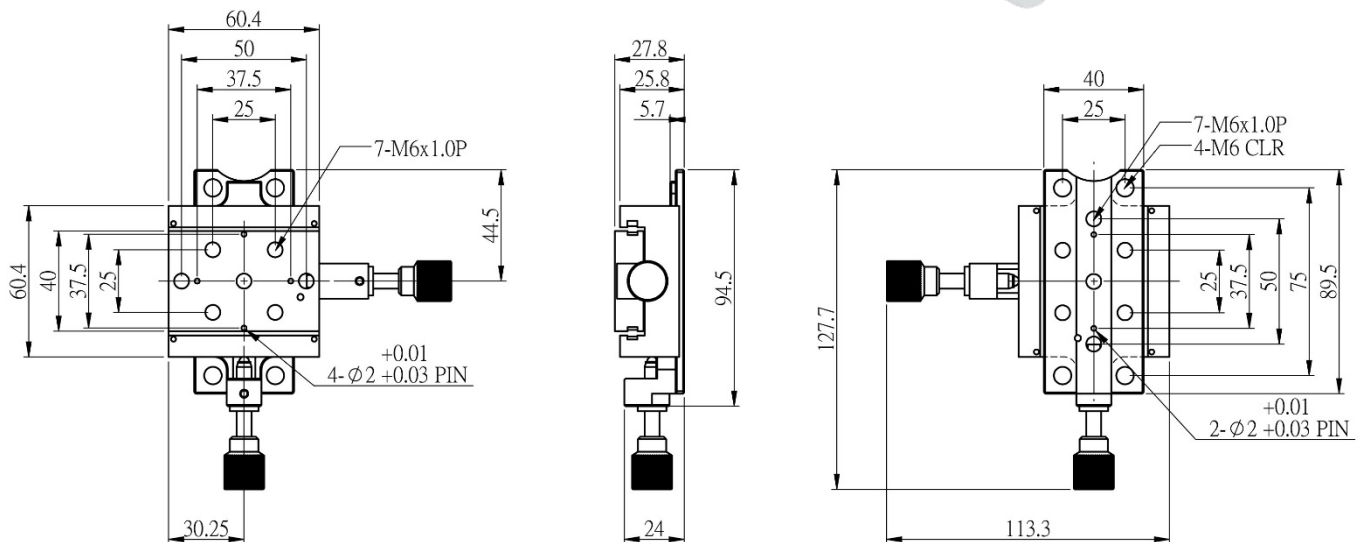

TCM60XY-05A-R

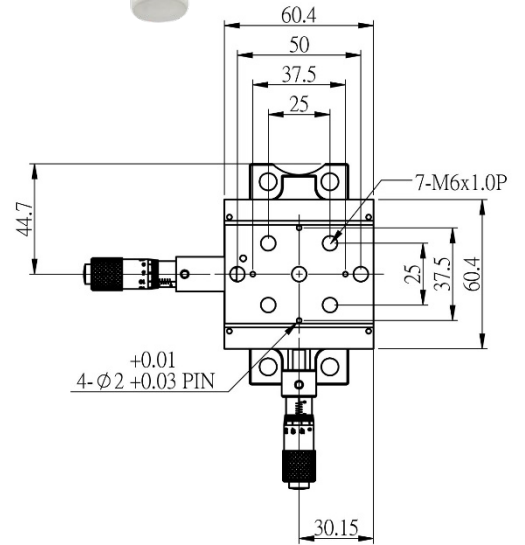
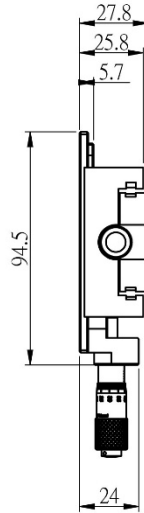
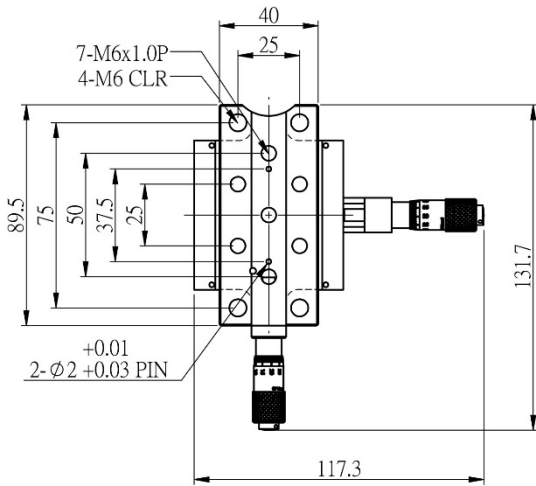

TCM60XYZ-05-L

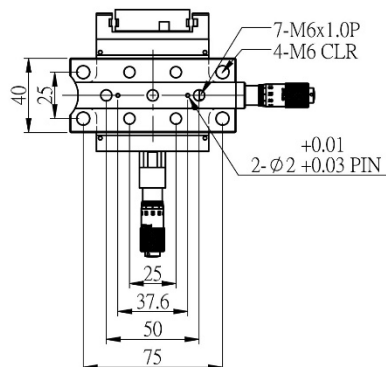
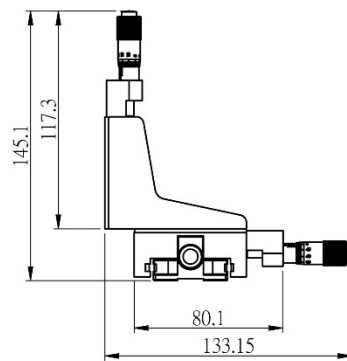
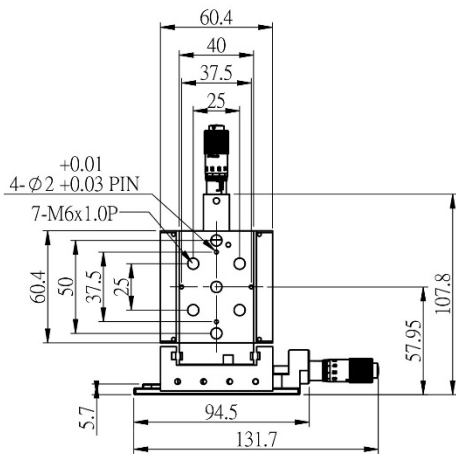

TCM60XYZ-05-R

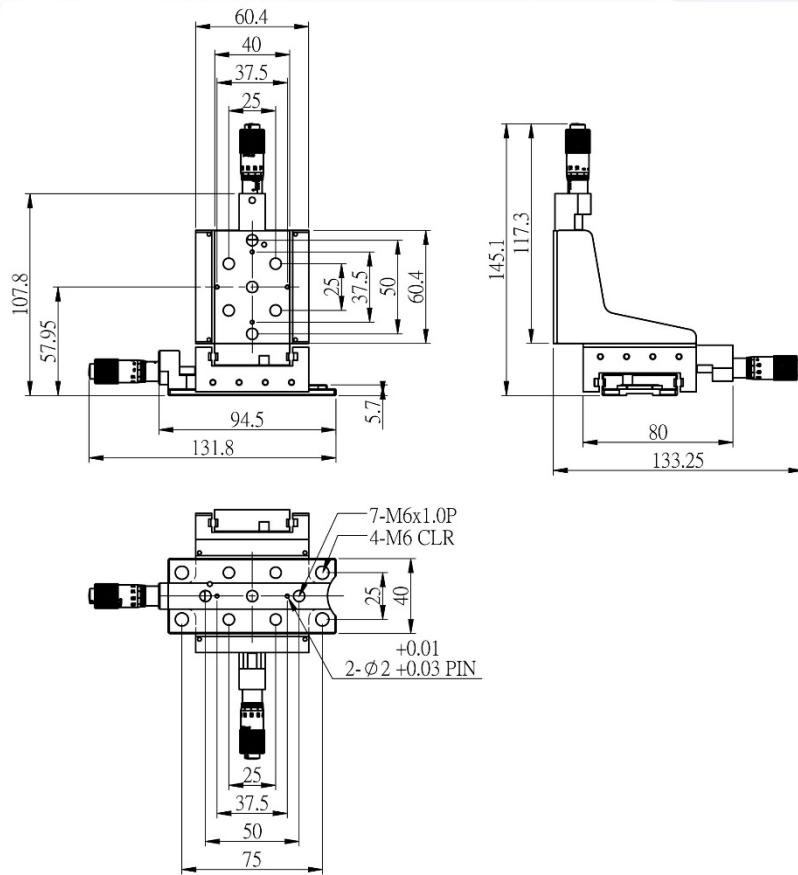

TCM60XYZ-05A-L

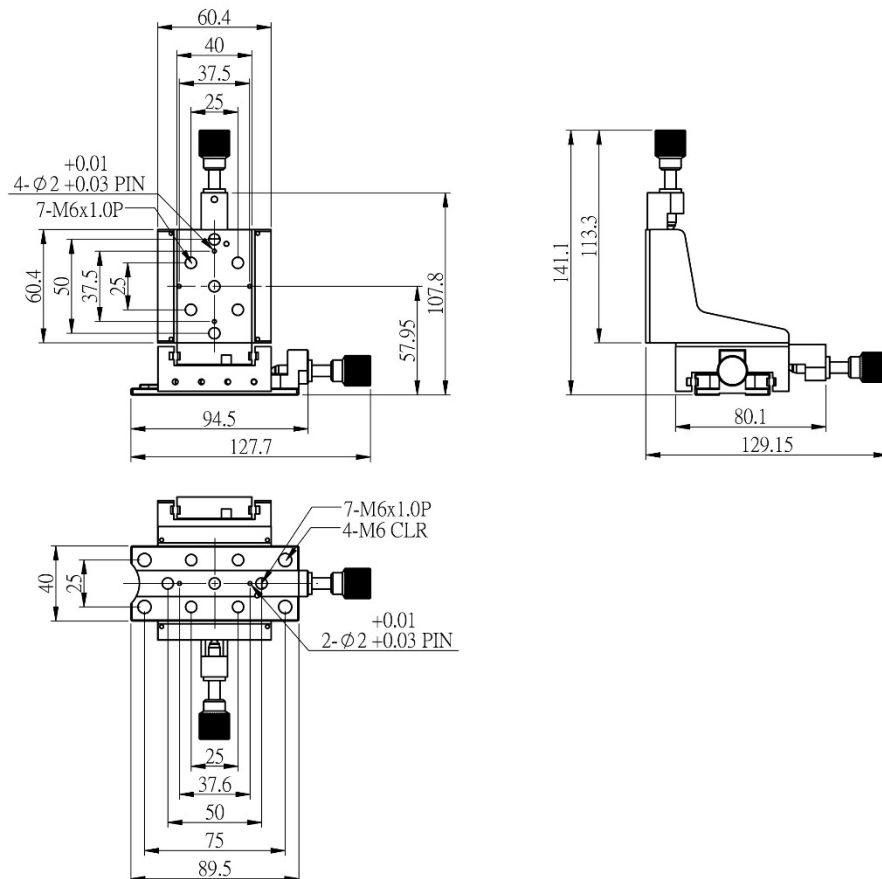

TCM60XYZ-05A-R

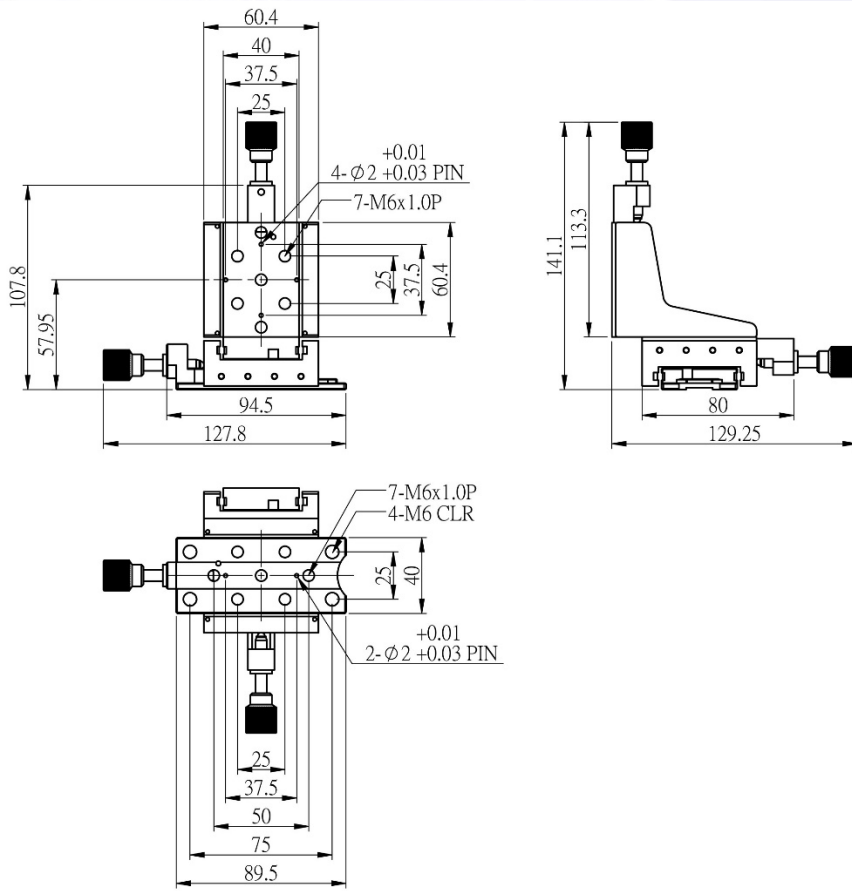

TCM60Z-05

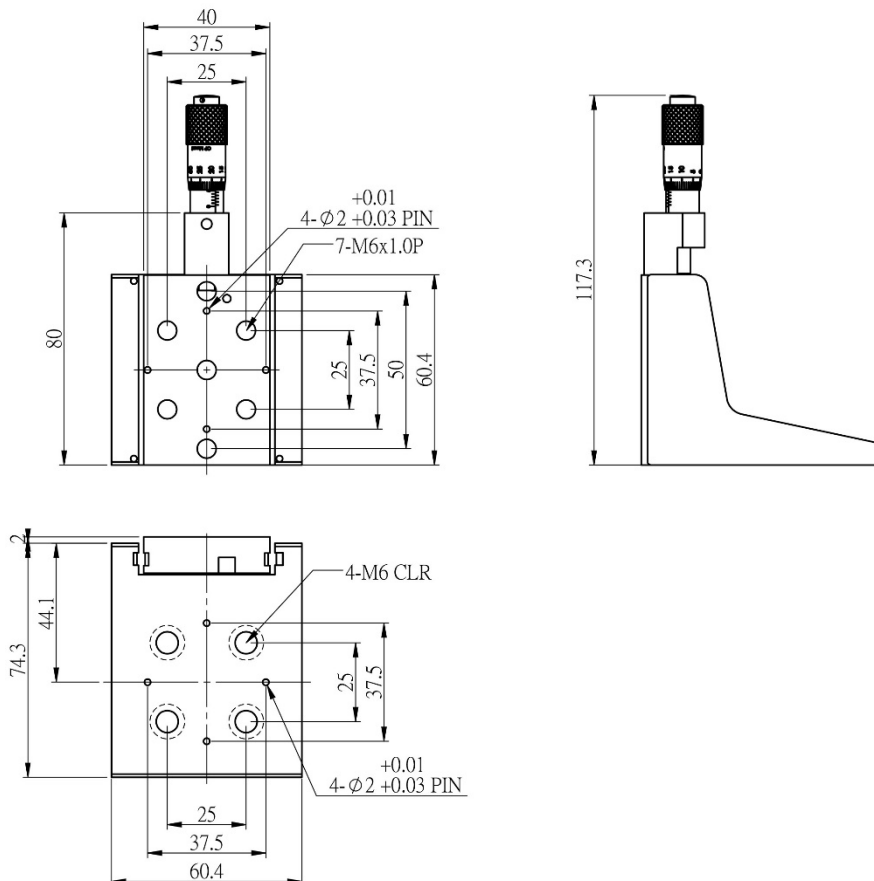

TCM60Z-05A

